

New Look-  
Same Exceptional  
People and Products

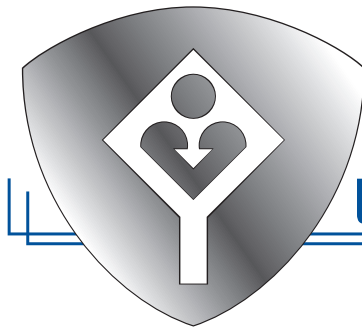

**VULCAN**  
UTILITY SIGNS

*Mark It To Protect It*

*Leading The Industry For Over 30 Years*



Product Catalog

*Find out how we can help you...*

**MARK IT TO PROTECT IT >>**

# OUR TEAM



Cody, Cyndi, George, Sherry, Donna, Stacy and Deborah  
Sales, Marketing and Customer Service



Bob Hamlin  
Vice President



Kathy Hawkins  
Sales Manager



Leonard Dixon  
Outside Sales



Production Team

## About Vulcan

---

Vulcan began as a small sign manufacturer in Birmingham, Alabama in 1935. Steadily increasing sales over the ensuing years required new production facilities, which resulted in a move of operations to the Gulf Coast of Alabama in 1968. Today, our 30 acre campus in Foley, Alabama includes five integrated manufacturing facilities and a Technical Development Center. Our expertise includes the manufacturing of utility signs and markers, traffic control signs, aluminum coil, aluminum blanks, aluminum sheet, custom metal stampings and our own traffic control device asset management software.

## About Vulcan Utility Signs

---

Vulcan Utility Signs, a division of Vulcan, Inc., specializes in the manufacturing of marking products for the utility industry. Primary markets include pipelines, communications, electrical power, and water/wastewater. This catalog provides an overview of the various types of marking products available, however our capabilities are not limited to the items shown. Vulcan Utility Signs stands ready to provide custom products in accordance with the latest industry standards.

### E-commerce

For our qualified business customers, we offer a range of free services that can save your company time and money. These services are just a mouse click away... on our secure Web Store. A customer with a contract account can be provided a customized, Web Store Corporate Access Page (CAP) designed specifically for the products a company purchases. Please contact us for details.

### Market Awareness

We are an active supporter and participant in the Southern Gas Association and the Texas Gas Association. We keep in tune with this market by attending conferences to display our products and by discussing products with our customers. Our association with these organizations, has enabled us to understand the drivers that influence natural gas companies such as shareholder value, total cost of ownership, communication and supply chain innovations.

### Graphic Design

Our Graphics Department has the knowledge and experience required to assist in the design process of signs and markers. Drawings and layouts can be provided to a customer to insure 100% customer satisfaction.

### Research & Development

Products are continually tested to insure the best field performance. Our outdoor test rack allows real time testing of current products as well as products in the developmental stages. An in-house QUV weatherometer test station is utilized for simulating normal to extreme environmental conditions. Through these testing processes, we are able to maximize the life expectancy of products.

### Liability

Our products are manufactured in accordance with each company's specifications, with particular attention to the current governmental requirements pertaining to each utility. However, Vulcan's primary responsibility is to meet customer design criteria, and no liability is assumed for items not in compliance with other regulations.

### Warranty

Vulcan warrants all products to be free from defects in materials and workmanship. In the event of a problem replacement or repair, orders receive top priority in our production schedule. We stand behind our products and strive to resolve all problems quickly and to the customers' satisfaction.



**1-800-426-1314**

**FAX: 251-943-9290**

**E-MAIL: [VULCAN7@VULCANING.COM](mailto:VULCAN7@VULCANING.COM)**

**WEB SITE: [WWW.VULCANING.COM/VUS](http://WWW.VULCANING.COM/VUS)**

**P.O. BOX 1850 FOLEY, AL 36536-1850**

# LINE MARKER SIGNS



Know what's below.  
Call before you dig.

Line Marker Warning Signs are your first line of defense in the prevention of asset liability and are an integral part of your damage prevention program. Something this important should only be trusted to the professionals at Vulcan. We offer consulting and design services to ensure your marking products meet all federal regulations.

Common sizes for line marker signs are 12 x 9 and 10 x 14. Custom sizes are available.



When designing a pipeline marker, consider the following:

- Does your marker need to incorporate the 811 logo or No Dig Symbol?
- Does your marker conform to the APWA Color Codes?
- Does your marker include a Notice/Damage Statement?
- Does your marker need to be multilingual?
- Does your marker need to be reflective for nighttime visibility?



Our marking products comply with the CFR-49-192.707 and CFR 49-195.410 requirements.





Know what's below.  
Call before you dig.

# LINE MARKER SIGNS

11 3/4" round warning signs can be made from aluminum or high density polyethylene (HDPE). The standard thickness for aluminum is .050" and for HDPE is .110". Other thicknesses are available upon request.

Messages are screen printed with thermal set polyester inks on aluminum and matched component inks on HDPE for excellent durability. Holes are punched according to customer specifications or use one of the standard locations below.



## COMMODITIES USED WITH STANDARD FORMATS

Acetylene	Finished	Natural Gas
Benzene Resin	Product	Nitrogen
Brine	Fuel Oil	Paraxylene
Buried Cable	Heavy Fuel Oil	Petroleum
Butadiene	Inert Gas	Petroleum Resin
Butyl Alcohol	Isobutane	Propane
Crude	L P Gas	Propylene
Ethane	L P G Products	Vinyl Chloride
Ethylene	N G L	Water

## BACKSIDE PRINTING



Backside printing provides additional space for a message without the added expense of two signs. Space is left open in the center of the signs for vertical post mounting.

## STANDARD HOLE LOCATIONS

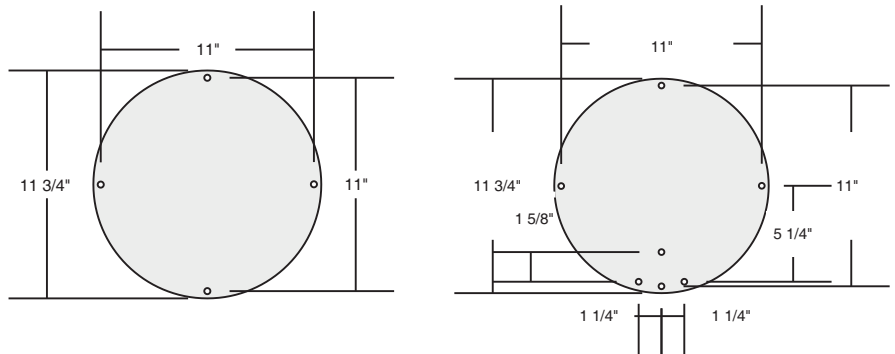

**Our marking products comply with the CFR-49-192.707 and CFR 49-195.410 requirements.**



## NOTICE STATEMENTS



### ARE YOUR SIGNS BEING STOLEN OR VANDALIZED?

Federal Law makes destruction or removal of these signs punishable with fines as high as \$5,000.00 and imprisonment of up to one year!

*(d) Any person who willfully and knowingly defaces, damages, removes or destroys any pipeline sign, right-of-way marker or maritime buoy required by the NGPSA, the HLPESA or the HMTA or any regulation or order issued thereunder shall, upon conviction, be subject, for each offense, to a fine of not more than \$5,000, imprisonment for a term not to exceed 1 year or both.*

This is an excerpt from the United States Department of Transportation, Pipeline Safety Regulations 49CFR Section 190.229 Criminal Penalties (D).

A **NOTICE STATEMENT** can be added to any standard line marker sign. Some examples are shown below.



Excerpt from United States Department of Transportation, Pipeline Safety Regulations 49CFR Section 190.229 Criminal Penalties (D)

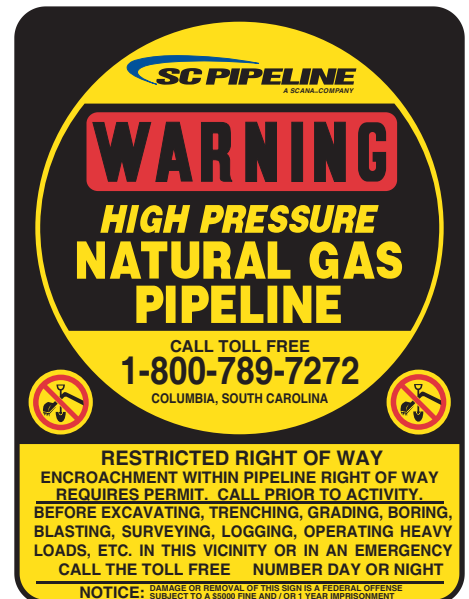
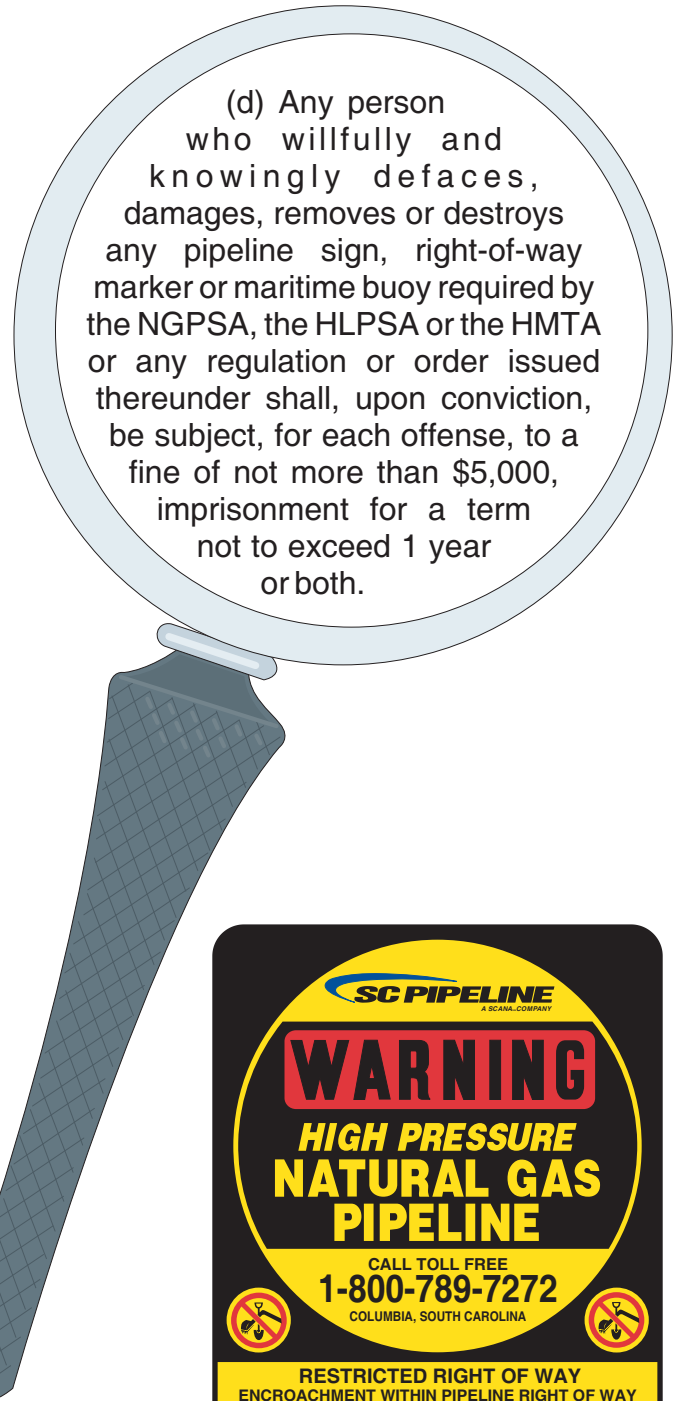



Know what's below.  
Call before you dig.

## GALVANIZED ANGLE POSTS

Holes are 3/8" diameter on 1" centers and will accommodate signs with hole placement between 5" to 20" centers

Manufactured in-house from 11 gauge galvanized steel.

Any standard post driver can be used. Length is 6', weight is 4 lbs. Tapered End.

Economic alternative to u-channel post.



## U-CHANNEL POSTS

- Hot rolled posts from high carbon steel for superior strength.
- Mounting Holes - 3/8" diameter on 1" centers, entire length.
- Finish - Green Painted, Galvanized or Powder coated: yellow, orange or white.
- Lengths & Weights - Various lengths and weights are available. Call if the size and color needed is not listed.

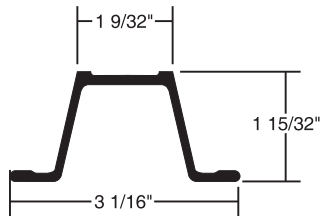
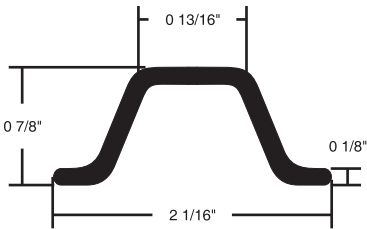

Part #	Lngh - Wght/ft	Finish
0550117	6' - 1.12#	Galv
0550118	6' - 1.12#	Green
0500001	6' - 1.12#	Yellow
0550134	7' - 1.12#	Green
0550135	7' - 2#	Galv
0550136	7' - 2#	Green
0550143	8' - 2#	Galv
0550145	8' - 2#	Green
0550049	10' - 2#	Galv
0550051	10' - 2#	Green

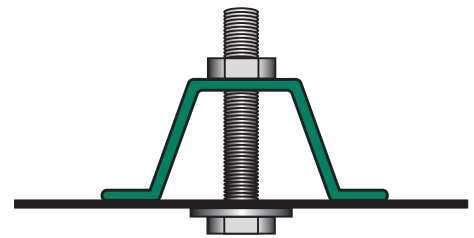

Proper Mounting Technique

## POST DRIVERS

### Lightweight Post Driver

For driving 1.12 lbs/foot post.  
Weight - 21 lbs.  
PN 0550021

### Handy Handle Heavy Duty One Man Driver

For driving 2 lbs/foot post.  
Weight - 38 lbs.  
PN 0550005

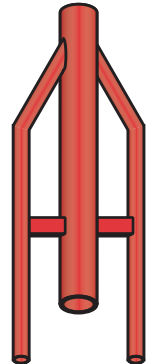

Vulcan's Drivable (DRV) Marker is a fiberglass based composite marker developed to drive easily in all soil conditions while maintaining flexibility.

- Will not rust, rot or corrode.
- Remains stable in temperatures from  $-30^{\circ}$  to  $+120^{\circ}$  - will not embrittle in cold temperatures nor soften in heat.
- Lower freight costs compared to steel post markers.
- Contains the highest fiberglass content in its class.
- Superior strength and easy to drive in soil.
- Absorbs vehicular impacts and returns to original position.
- Ultraviolet inhibitors provide long term product stability and color retention.



- Never needs painting as color is the same throughout the marker.
- Will survive controlled ditch burns which often melt or destroy plastic markers.

## SPECIFICATIONS

- Standard length = 66"
- Other lengths = 60", 72", and 78"
- Colors available = Yellow, Red, White, Blue, Green and Orange
- Custom colors also available
- Weight per foot = .58 pounds
- Fiberglass content = 65%
- Strongest DRV available

### UNIQUE DESIGN

Recessed design on both sides protect the vinyl sheeting from damage during installation or vehicle impacts.

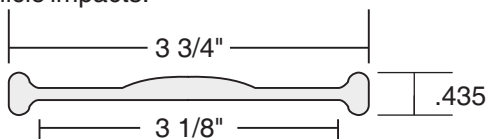

**Cross Section**

### ANCHOR KIT

Designed for anchoring markers in loose, sandy or marsh type conditions. Flexible anchor barb collapses during installation and expands during attempted removal. A pop rivet is supplied to attach the anchor. Kits are supplied separately. When ordering, specify anchor kit.

### VF - 105 INSTALLATION TOOL

Specifically designed for flat type markers, this economical and convenient tool makes markers easy to install. A worker can install a marker in less than one minute.





Know what's below.  
Call before you dig.

# DRIVABLE MARKERS

## DECALS FOR DRIVABLE MARKERS



- ← “No Dig” Symbol - easily recognized by all excavators
- ← **Warning of Federal Law**
- ← Contrasting **Warning** message for maximum visibility
- ← Large Black letters meet **Federal Requirements**
- ← Top-quality, premium cast **vinyl** film with aggressive adhesive
- ← **Match Component System Inks** used for maximum longevity
- ← 3” wide by 12”, 16” or 18” length
- ← Decals with protective overlay applied to marker before shipping
- ← **Company Name and Emergency Phone Number**
- ← **One-Call Phone Number**
- ← **811 Decal**

**Our marking products comply with the CFR-49-192.707 and CFR 49-195.410 requirements.**



## H41 MARKER

The H41 Marking System is the most versatile marker in the industry today. This marker is made from specially formulated, UV protected, High Density Polyethylene (HDPE). The marker provides 360° visibility and can be adapted several ways to meet your requirements.

The most common application of the H41 Marker is to apply a premium vinyl wrap decal to a 3 1/2" OD post along with a top cap and anchor. Our standard wrap decal repeats your message three times for true 360° coverage. For additional nighttime visibility the wrap decal can be made from Engineer Grade reflective sheeting.

A more durable application would be to substitute a thin gauge aluminum wrap sign for the wrap decal. This application takes advantage of the proven thermoset polyester ink system in a 360° application. The wrap sign is roll-formed and then mechanically fastened with rivets to the post. The most durable application is a bullet top which also employs numerous decorating options for use in virtually any field situation. Page 9 describes these options in more detail.

A u-channel stub may be used for quicker installation. The stub allows a 2#/foot u-channel section to be driven into the soil then a shorter version of the H41 can be attached to the stub. The u-channel stub makes this application very sturdy!



Colors	
➤ White	➤ Red
➤ Yellow	➤ Blue
➤ Orange	➤ Black
Other colors available.	
<p><b>H41 Lengths</b> Standard lengths are 6 ft. and 8 ft. Custom lengths available.</p>	





Know what's below.  
Call before you dig.

# H41 LINE MARKER SYSTEM

## H41 BULLET MARKER

The H41 Marker provides 360° visibility for superior line identification. The marker post and bullet top are made from specially formulated, UV protected High Density Polyethylene (HDPE).

To create multi-color printing possibilities, unique treatments and inks are used. The bullet is slipped over and attached to a post of the same or contrasting color. The marker post has an outside diameter of 3 1/2".

Pipe Colors	Bullet Colors
➤ White	➤ White
➤ Yellow	➤ Yellow
➤ Orange	➤ Orange
➤ Blue	➤ Red
	➤ Blue

**H41 Lengths**  
Standard lengths are 6 ft. and 8 ft.  
Custom lengths and colors available upon request.



The H41 Bullet Marker may be installed as a stand alone unit, or it can be slipped over and attached to a u-channel post. For the stand alone version, a soil anchor is provided.

Specify the desired marker length, post color, top color, company information and the commodity being transported.

**Our marking products comply with the CFR-49-192.707 and CFR 49-195.410 requirements.**

## H41 VENT MARKER



The H41 Vent Marker is designed to fit over and attach to a standard 3 1/2" or 2 3/8" OD riser pipe. In addition to acting as a warning marker, the vented bullet head allows for detection of gas leaks.

The marker eliminates labor required to paint and repaint risers while providing a more professional appearance.

The inside diameter of the H41 Vent Marker is 3.75" for the 3 1/2" riser and 2.5" for the 2 3/8" riser.



## H41 CATHODIC TEST STATION



H41 Cathodic Test Station with HDPE Sleeve

The H41 Cathodic Test Station utilizes the same specially formulated High Density Polyethylene (HDPE) pipe with UV inhibitors. The length of the marker can vary depending on your needs. The most common length is 6' long, which comes with a barb anchor to secure the marker in place.

The Cathodic leads are routed up the post for attachment to the terminals. More information on the Test Head can be found on page 22.

There are three decorating options available for the H41 Cathodic Marker. Each option involves the capability of being screen printed with a complete "WARNING" message, along with operator name and phone number to ensure compliance with The Department of Transportation's Code of Federal Requirements for a line marker. The three decorating options include the following:

- HDPE Sleeve (See photo at left)
- Thin Gauge Aluminum Wrap Sign
- Outdoor Wrap Around Decal



Injection Molded Cap

## H41 BULLET CATHODIC MARKER

Vulcan's H41 Bullet Cathodic Marker utilizes our screen printed Bullet Head top to conceal the test points of the Cathodic leads. This product provides the same "look" as an H41 Bullet Marker and thereby does not draw attention to its importance.

A specially fabricated board of polycarbonate is mounted inside the rigid HDPE tube. Five brass terminals with double nuts are assembled to the board for attaching the wires. Leads can be routed up the tube making for easy attachment to the labeled board. Leads are not provided.



## H41 BULLET LOCATOR



Vulcan's H41 Bullet Locator utilizes our screen printed Bullet head top to conceal the connections of the tracer and ground wires. This product provides the same "look" as an H41 Bullet Marker and thereby does not draw attention to its importance.

A specially fabricated board of polycarbonate is mounted inside the rigid HDPE tube. Three brass terminals with double nuts are assembled to the board for attaching the wires. A uniquely designed copper conductor provides connectivity across all three wires. Easy access makes the process of removing one wire and attaching the test equipment quick and convenient.



Know what's below.  
Call before you dig.

8 1 1 - CALL BEFORE YOU DIG



# Know what's below. Call before you dig.

*Common Ground Alliance (CGA) is promoting a national Call 811 Campaign encouraging everyone to "Call Before You Dig!"*

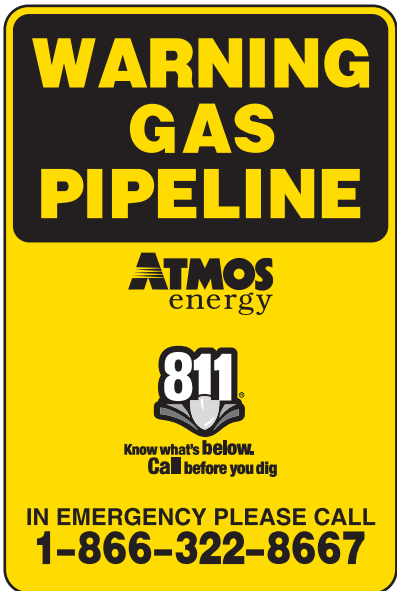

VULCAN UTILITY SIGNS can provide the materials to participate in this campaign.

Decals with the new 811 information can be used to cover existing phone numbers on signs.



We can help design signs, markers and decals which incorporate the 811 logo.

## BENT STYLE



Each aerial plate is attached to the bent frame using special blind rivets. As shown in the photograph (top right), the plates are supported in the center, giving optimum stability in windy conditions.

The bent frame is fabricated for attachment to our aerial marker post. This special post is 2 3/8" OD x 10' with a plate welded for assembly with the bent member. The assembly is illustrated in the photograph (bottom right). Four fasteners come with each bent member to complete this assembly.

The photo at top left shows a bent style aerial marker assembled to a standard u-channel post. A special u-channel mounting adaptor is required as illustrated. We can fabricate virtually any mounting bracket to an existing post that will allow installation of the bent style frame.

## UNIQUE, INNOVATIVE AND VERY SIMPLE IN DESIGN

The integral component of the aerial marker is the bent frame. Each bent frame is precisely fabricated from .100" thick highway grade aluminum. After fabrication, the sides are bent to 45°. The design is open at the top and bottom, so that concealed areas are not available for insects to nest.



### END VIEW

Illustration of the component parts on a round post.

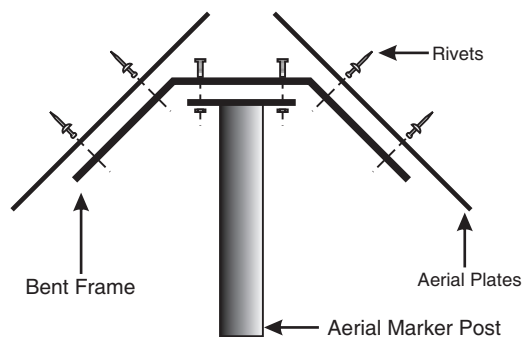

BENT STYLE FRAMES			
Part #	12" Wide	Part #	8" Wide
0700041	1-Digit	0700046	1-Digit
0700042	2-Digit	0700047	2-Digit
0700043	3-Digit	0700048	3-Digit
0700044	4-Digit	0700049	4-Digit
0700045	5-Digit	0700050	5-Digit
0700051	U-Channel Mounting Adaptor		
0500011	Aerial Marker Post		



U-Channel Post With U-Channel Mount



Know what's below.  
Call before you dig.

## BENT STYLE

### ADVANTAGES OF BENT STYLE OVER FRAME STYLE MARKERS

This style allows the Bent Frames to nest on each other which creates several advantages over the frame style marker including:

- Less storage room prior to installation.
- More markers can fit into a work truck, saving return trips.
- The Aerial Plates can be installed on the Bent Frame prior to going into the field, which creates the head. Aerial marker heads will also nest after the plates have been installed.
- Considerable freight savings over the aerial marker frames due to shipping by weight rather than by volume/density. Aerial marker frames' freight cost is 4 to 5 times more per pound than bent frames (See photo below).



Aerial Markers Packed For Shipping  
50 Bent Style vs 50 Frame Style

### PLATES FOR BENT STYLE

Sizes are the same as standard frame style plates except the mounting holes are positioned to attach to a bent frame.

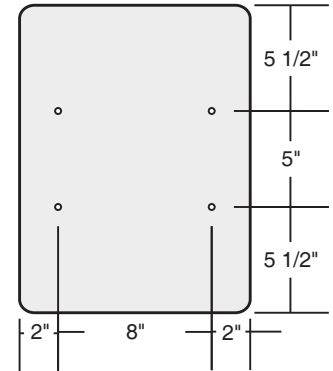

5/16" diameter holes

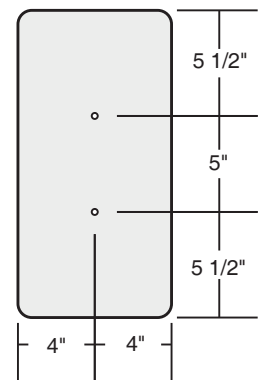

5/16" diameter holes

### TIPS ON SELECTING THE CORRECT SIZE AERIAL MARKER

Aerial plate size is based on altitude of flight and terrain, which can be best determined by aerial patrols. After resolving plate size, select a mounting method (round post, u-channel post, etc.) Finally, verify the frequency of the markers - every mile, two miles, etc. From this information we can provide a price list including all components.

## FRAME STYLE

- Aluminum frames are fabricated from 1" and 1 1/2" x 1/8" aluminum angle alloy 6063-T5.
- Three standard mounting methods are illustrated. Other mounting methods are available.
- Hardware is supplied for mounting signs to frames.
- Width of each frame depends on the number of plates to be used and the size of plates.
- Individual plates can easily be replaced.
- Additional braces can be provided.

### **STEEL FRAMES ARE AVAILABLE!**

Aerial Frames are fabricated from hot rolled steel and are hot dip galvanized after fabrication.

### ROUND POST MOUNT



### WOOD POST MOUNT



- Mounts to wood post with lag screws in the plate and through both lower mounting arms.
- The lower arms can be made adjustable for varying widths of wood posts.
- Specify width of post when ordering.

### U-CHANNEL POST MOUNT



- Frame bolts to a 2 lbs./ft. u-channel post.
- No field drilling required.
- Center mounting plate is welded to the top and bottom lower mounting arms.



Know what's below.  
Call before you dig.

# AERIAL MARKERS

## FRAME STYLE

### PLATES FOR FRAME STYLE MARKERS

- Standard thickness of aluminum for number plates is .050". Other thicknesses available.
- Plates are prepunched for any frame style on opposite page.
- Sign message conforms to Federal Highway Administration (FHWA) standard series fonts.
- The most common color combination is black on yellow. Other combinations are available.

### TWO MOST COMMON SIZES



8 x 16  
12" character



12 x 16  
12" character

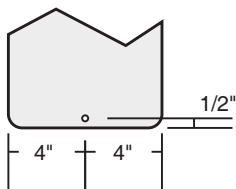

1/4" diameter holes

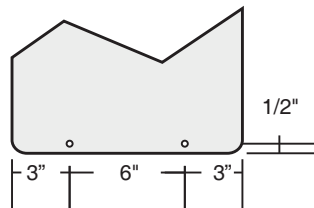

1/4" diameter holes

Other sizes available:

- 6 x 9
- 6 x 12
- 9 x 16
- 12 x 24
- 18 x 24

Custom fabrication of any size marker available upon request.

### DECIMAL PLATES

Decimal Plates are the same size as the standard plates used. The character height is reduced by approximately 25% and a decimal is added. Decimal plates permit a more exact placement of markers in easily accessible areas.



12 x 16

### COLORS IN STOCK



### CHANGE OF DIRECTION

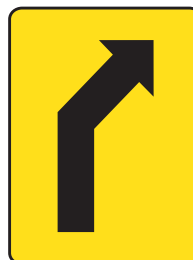

45° RIGHT



INTERSECTION



90° LEFT

## SIGNS

- Sign panels are .090" thick aluminum alloy 5052-H38. Other size panels are available.
- Panel is fabricated to mount to a supporting structure, such as fabricated sign frames, horizontal zee bars or vertical uprights.
- Multiple panel signs are typically installed using horizontal zee bars. All zee bars are punched to mount on sign panels and vertical uprights.
- Vulcan can fabricate a complete welded aluminum frame utilizing zee bars and aluminum angle to customer specifications. Ready-made sign frames reduce installation time and labor costs.
- Fasteners for mounting panels to zee bars or frames are included with each sign.

The photo below shows a sign assembly which includes a diamond warning sign along with a rectangular sign. The legend on both signs has a Regulation Notice Statement pertaining to malicious damage and/or removal of the signs.



## SIGN PACKAGE

**We offer complete packages to mark any river crossing. The package includes:**

- Two 8' x 4' signs
- Four 14'-3# galvanized u-channel post (vertical support)
- Four 8'-2# galvanized u-channel post (horizontal bracing)
- All mounting hardware with installation instructions

### NIGHTTIME VISIBILITY

Engineer grade reflective sheeting can be used to manufacture a sign for the added benefit of nighttime visibility. An orange margin made with the same reflective sheeting can also aid in making the sign more visible at night.





Know what's below.  
Call before you dig.

SIGNS

Below is the typical construction detail as viewed from the back of the sign. This illustrates the use of 3" Zee Bar for horizontal bracing. Signs of other sizes follow the same pattern. Contact us for complete details and drawings for your requirements.

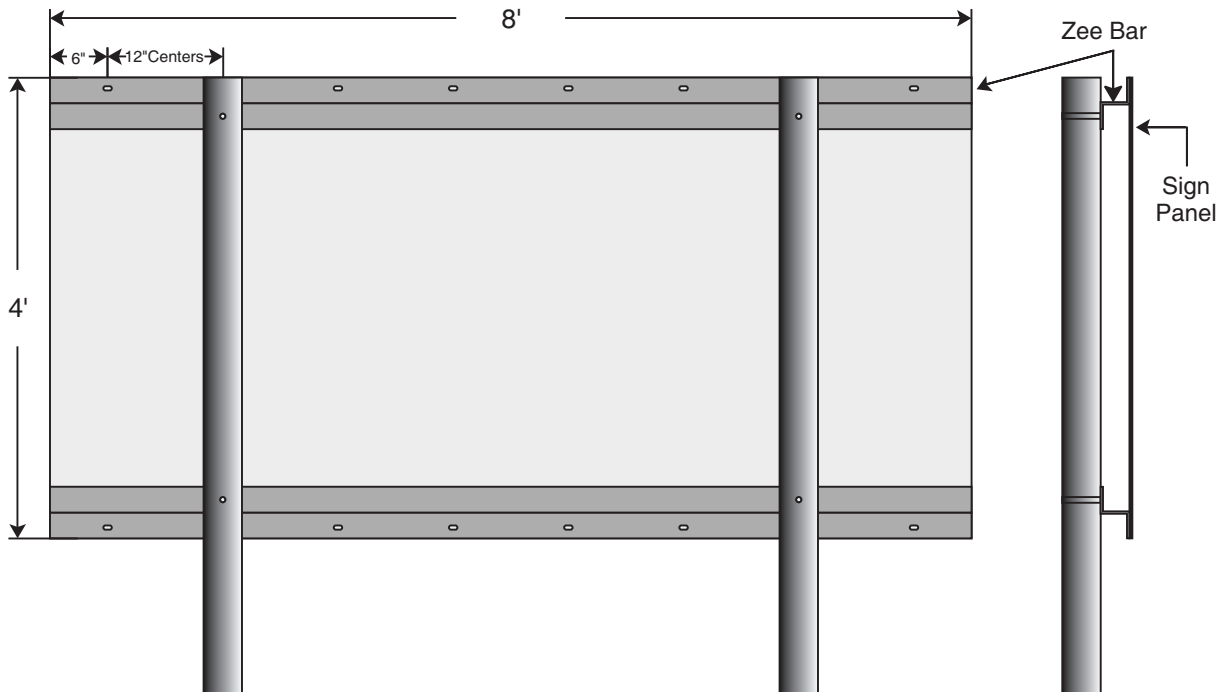
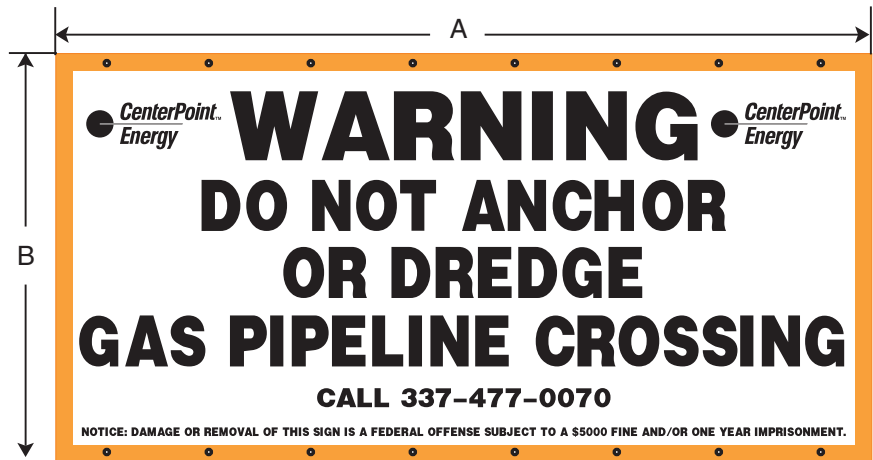

VISIBILITY CHART FOR SIGNS

A	B	Visibility Range	# of Panels	Panel Size	# of Zee Bars
4'	2'	300'	1	4' x 2'	2
6'	3'	450'	1	6' x 3'	2
8'	4'	600'	1	8' x 4'	2
12'	6'	900'	3	4' x 6'	3
12'	8'	1100'	3	4' x 8'	3
16'	8'	1250'	4	8' x 4'	4



## MAX-VIEW MARKER

Vulcan's Max-View Markers are a great way to rebrand an existing line or marker for a fraction of the cost of purchasing new markers. For a quick update, simply slip a Max-View Marker over the current marker then fasten to the existing structure. These markers also greatly enhance the visibility of your lines.

THE MAX-VIEW MARKER PROVIDES THE GREATEST 360° VISIBILITY OF ANY MARKER IN THE INDUSTRY TODAY.

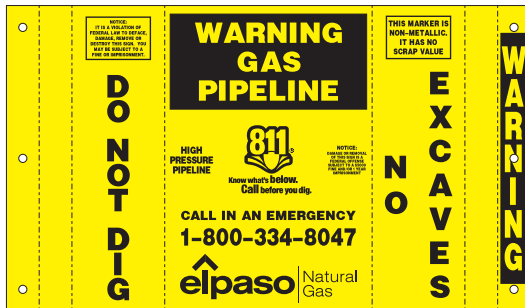

Max View Markers can be used to:

- Change a phone number
- Update a company logo
- Update a company name
- Comply with new regulations (such as the 811 One Call)

- High visibility for multi-lingual messages
- No Decals required
- Message printed directly on surface for maximum durability.
- 22" length
- Available colors are yellow, red, white, blue, green and orange
- Easily attached to a post with rivets





Know what's below.  
Call before you dig.

# SPECIAL APPLICATION MARKERS

## SPECIAL APPLICATIONS

In addition to standard warning markers, other signs and markers can be essential to a pipeline. Several examples are shown below - call with your specifications.

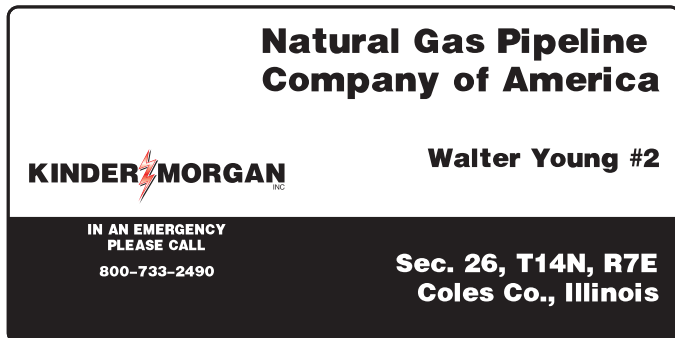
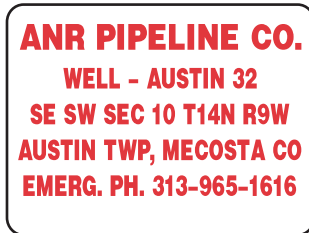
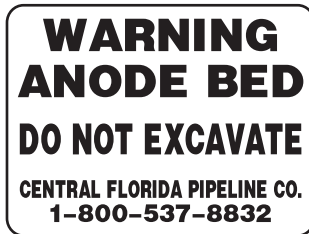
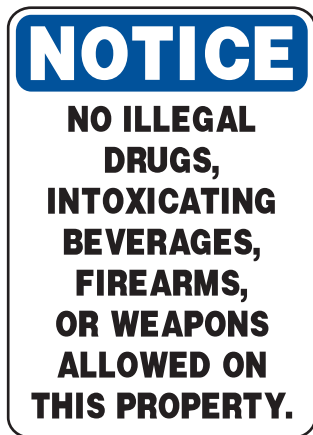
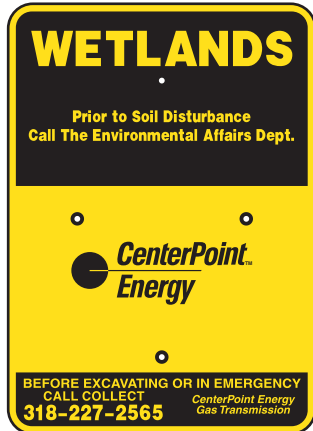

## SLIMLINE BOUNDARY MARKER

The SlimLine Boundary Marker is the perfect solution to long term temporary marking for observation and monitoring zones of excavation areas since they can be easily removed once a project is completed. These markers are manufactured from fiberglass composite, have a 1" diameter and are tapered at the end for easy installation.



Customized reflective decals with your company logo and phone number can be applied to provide continual visibility. These durable, reusable markers can be cut to meet your specific height requirements and come in a variety of colors.

A custom information panel can be attached to these markers when a larger message is required.



## HIGH DENSITY AREA MARKERS



Designed specifically for landscaped areas where traditional markers would be inappropriate.

The message is screen printed on the backside of the polycarbonate face to protect the message from surface scratches. All aluminum construction.

Standard sign size is 10" x 7".

## SOIL MARKERS



Vulcan's Flush Mounted Soil Markers are a reliable, effective method for marking any underground facility. The 7" round marker is a great identification marker for high density, manicured areas.

- In-molded graphics for scratch resistant durability
- Anchors evenly at ground level with 13" stakes
- Can be mowed over, walked over and visible from a vehicle
- Excellent choice for long-term temporary marker
- Reduces the need for multiple relocations.

## das Curb Markers®

For situations where traditional markers are not appropriate, such as urban and upscale residential areas, DAS Markers are a perfect alternative.



The DAS Marker is highly durable and simple to install. Apply the DAS adhesive to the marker then place on curbs, sidewalks, roadways, etc.

## PAVEMENT MARKERS

The Vulcan Pavement Marker is an inexpensive and quick way to identify your pipeline, fiber/copper, or any buried utility when traditional markers are not appropriate (i.e. urban and residential areas).

Adhesive is not required to install these pavement markers. Simply peel off the back and place markers in position. For best results, the pavement area should be free of oil and/or any debris that could interfere with the adhesion of the marker. Temperature should be at least 60° F.

Custom markers can be provided with your company name and phone number.



Standard sizes are 5" x 4" and 10" x 4".  
Other sizes available.



Know what's below.  
Call before you dig.

# MARKING AND LOCATING TOOLS

## UNDERGROUND TAPES

This product is the most effective product currently available for protecting your buried utilities from dig-ins. Its six ply construction provides the unique combination of high strength, high puncture resistance and superb elongation allowing it to stretch out of the ground across the backhoe's bucket without breaking.

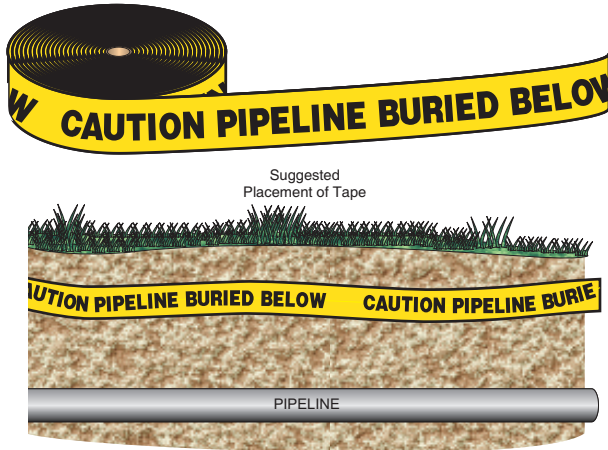

**CAUTION GAS LINE BURIED BELOW**

Any style tape is available with the above message in 3" x 1000' or 6" x 1000' rolls. **Custom imprints with your company's name, logo or message are available.** Call for details!

## ELECTRONIC MARKERS

### OMNI MARKER™

U.S. Patent 5,699,048, other patents pending



Omni Markers provide a quick way to electronically identify buried facilities for future relocation. The markers can be buried during construction or maintenance

phases, allowing the marked areas to be found quickly using most modern marker locators.

24 per case  
Locator Available

## TEMPORARY MARKING

Our weather resistant flags are imprinted with standard or custom messages. These polyethylene flags are heat welded to a steel shaft to prevent separation.



Flags are 4" x 4" or 5" x 4", shaft is 21" 30" and 36". Flags with plastic shafts are also available.

### Stock Standard Printed Message:

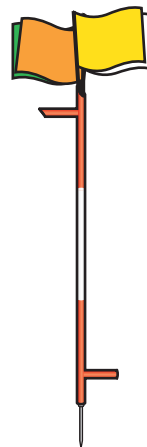

Message: Gas Line Below  
Text: Yellow  
Flag: Black

Message: Pipeline Below  
Text: Yellow  
Flag: Black

### Other Flag Colors

- Orange
- Blue
- Green
- Red
- Lime
- Pink

Various Fluorescent Colors

1000 Flags per Box

Flag Installation Tool . . .PN 1500209

**Inverted Cans of Spray Paint and Marking Guns are also available.**

Marking Gun - Long Shaft PN 1500042



## CATHODIC TEST HEADS

Vulcan Cathodic Protection is the trusted source when the risk of corrosion is evident. These rugged test heads are injection molded, using the finest polycarbonate plastics with UV protection which insures maximum strength and guards against failure due to prolonged exposure to sunlight.

Tools are not required to install these Cathodic Test heads.

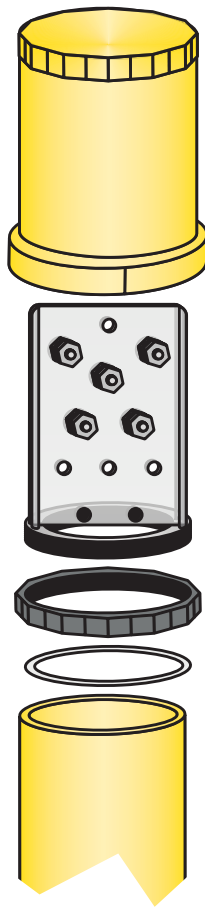

Available Colors		
➤ Orange	➤ Green	➤ Dark Blue
➤ Red	➤ Black	➤ White
➤ Yellow		➤ Light Blue

No. 3 for use with 3 1/2" OD Risers

No. 1 for use with 1 1/2" OD Risers

## CATHODIC DRV

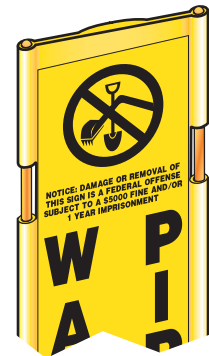

- The Cathodic Test Station doubles as a line marker.
- Exposed contact points are readily accessible.
- Consistent look in the marking of the entire run.
- Immediate access means no wait time for test head to thaw out in cold weather.
- Marker comes with two 21 ft., 12 AWG wires installed.
- Available colors are yellow, red, orange and white.





Know what's below.  
Call before you dig.

## H41 CATHODIC TEST STATION



H41 Cathodic Test Station with HDPE Sleeve

The H41 Cathodic Test Station utilizes the same specially formulated High Density Polyethylene (HDPE) pipe with UV inhibitors. The length of the marker can vary depending on your needs. The most common length is 6' long, which comes with a barb anchor to secure the marker in place.

The Cathodic leads are routed up the post for attachment to the terminals. More information on the Test Head can be found on page 22.

There are three decorating options available for the H41 Cathodic Marker. Each option involves the capability of being screen printed with a complete "WARNING" message, along with operator name and phone number to ensure compliance with The Department of Transportation's Code of Federal Requirements for a line marker.

The three decorating options include the following:

- HDPE Sleeve (See photo at left)
- Thin Gauge Aluminum Wrap Sign
- Outdoor Wrap Around Decal



Injection Molded Cap

## H41 BULLET CATHODIC MARKER

Vulcan's H41 Bullet Cathodic Marker utilizes our screen printed Bullet Head top to conceal the test points of the Cathodic leads. This product provides the same "look" as an H41 Bullet Marker and thereby does not draw attention to its importance.

A specially fabricated board of polycarbonate is mounted inside the rigid HDPE tube. Five brass terminals with double nuts are assembled to the board for attaching the wires. Leads can be routed up the tube making for easy attachment to the labeled board. Leads are not provided.



Pipe Colors	Bullet Colors
➤ White	➤ White
➤ Yellow	➤ Yellow
➤ Orange	➤ Orange
➤ Blue	➤ Red
	➤ Blue
Custom Colors Available	

H41 Lengths
Standard lengths are 6 ft. and 8 ft. Custom lengths available.

## VULCAN STANDARD VENT



- Vents are available for 2 1/2", 3", 3 1/2" and 4 1/2" O.D. vent pipes.
- Vents available in yellow, orange, white or red.
- Plated set screws are included for attaching to vent pipes.
- An aluminum screen is installed to keep insects and rodents out.
- Holes are drilled and tapped for mounting signs to the back of the vent.
- Custom decals can be applied to the vent or to the backside of a mounting plate to make the decal visible from any side.





## VULCAN VENT CAP

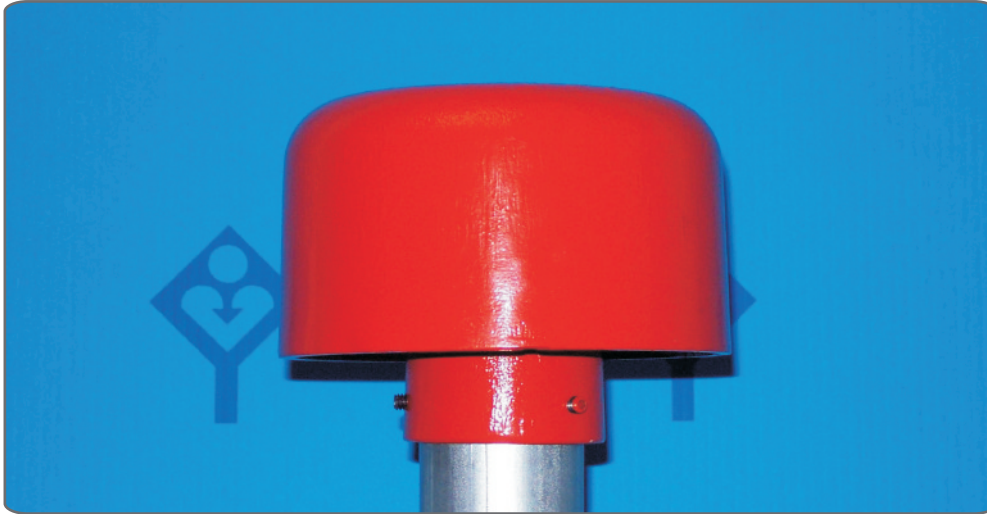

- Vents are available for 2 3/8", 3 1/2" and 4 1/2" O.D. pipe.
- Vents available in yellow, orange, or white.
- Plated set screws are included for attaching to vent pipes.
- An aluminum screen is installed to keep insects and rodents out.
- Custom decals can be applied on the cap perimeter.
- An optional sign bracket can be welded to the top of the cap to accommodate a warning sign.

## VULCAN NOODLE VENT



- Available for 2 3/8" risers.
- Vents available in yellow, orange, or white.
- Plated set screws are included for attaching to vent pipes.
- A plastic blow out plug is installed to keep insects out.

## VULCAN JUNCTION VENT

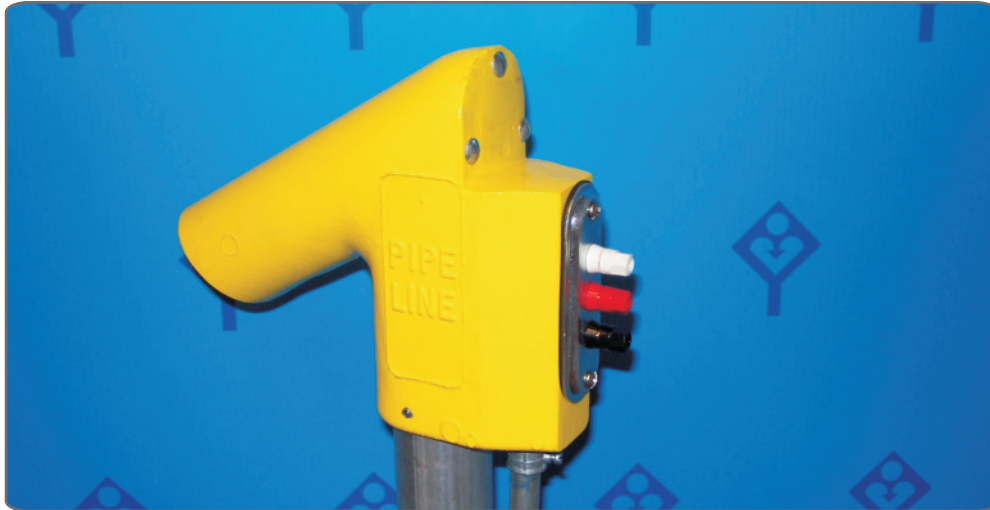

- Vents are available for 2 3/8", 3 1/2" and 4 1/2" O.D. risers.
- Vents available in yellow, orange, or white.
- Plated set screws are included for attaching to vent pipes.
- An aluminum screen is installed to keep insects and rodents out.
- Holes are drilled and tapped for mounting signs to the back of the vent.
- Junction boxes are drilled and tapped to receive 1/2", 3/4" or 1" conduit.

## VULCAN JUNCTION CAP



- Caps are available for 2 3/8", 3 1/2" and 4 1/2" O.D. risers.
- Caps available in yellow, orange, or white.
- Plated set screws are included for attaching to vent pipes.
- Holes are drilled and tapped for mounting signs.
- Junction boxes are drilled and tapped to receive 1/2", 3/4" or 1" conduit.



### What is an Excess Flow Valve?

An excess flow valve is a device designed to restrict gas flow in a natural gas service line by automatically closing when a line is broken, cut, torn or separated. Restricting gas flow after a line damage can decrease the potential for property damage or injury.

The Federal Department of Transportation is enforcing a new safety regulation that requires natural gas supply companies to notify certain customers of the availability of an Excess Flow Valve. Once this valve is installed, an “EFV Installed Tag” is required on the outside of the line for easy visual confirmation.

Vulcan’s EFV Tag Kit consists of the following:

- 2 3/8” round .032 gauge, rust free aluminum, with stamped message
- 6” Outdoor durable UV protected nylon zip tie for each tag.
- Packaged in zip lock bags of 50 for easy storage and accessibility.



Fleet Markings are manufactured in two forms which are prespaced legends and decals. Either form can be designed using a variety of materials including reflective and magnetic.



## PRESpaced LEGENDS

Prespaced Legends are computer cut in the exact shape of a logo or other object then covered with a protective premask tape. Once applied, the proper spacing and alignment of text and graphics is maintained which provides a look of being painted on a vehicle.

- Our graphics department can design a uniform marking system for your entire vehicle fleet.
- A complete marking kit, including an individual asset number for each vehicle can be supplied along with detailed installation instructions.



### CREW TRUCK APPLICATION GUIDE

Crew Truck Fleet Marking Kit Item # 0903237  
Provide Asset number with each kit ordered

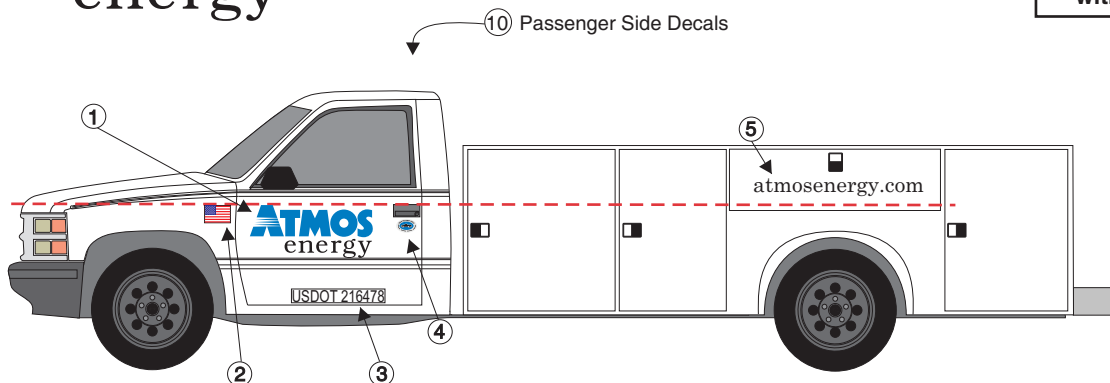

- ① Begin application on the driver side of the truck with the "Atmos energy" logo. Place the logo 3 3/4" down from the bottom of the window and position it left to right so that it is centered on the door without applying it over the door handle or any other major feature of the door.
- ② Apply the driver side American Flag to the driver side front fender. Place the top of the flag even with the top of "Atmos" and 1/4" from hinge edge of door (stars to front).
- ③ . . .
- ⑩ Apply the passenger side decals, following the instructions in 1, 2, 3, and 5.

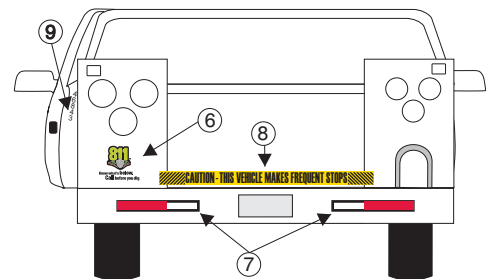



Know what's below.  
Call before you dig.

## DECALS

Decals are supplied with the entire design printed on a background. Custom reflective, non-reflective or magnetic decals can be designed and manufactured for company vehicles. Detailed application instructions are supplied with each order.

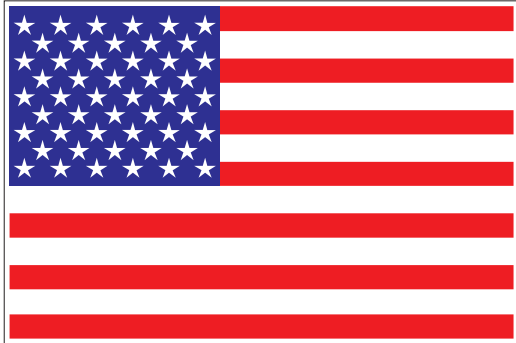

Know what's below.  
Call before you dig.

Keep safety a top priority! Increase the visibility of fleet vehicles and equipment by applying highly retroreflective microprismatic markings designed to mark the sides and rear of vehicles for enhanced visibility and detection.





Know what's below.  
Call before you dig.

Vulcan can manufacture virtually any style, size or color decal using reflective sheeting, vinyl or magnetic material. The scored decal backing simplifies the application process.



Order 811 decals to apply to existing markers or use in a public awareness campaign.



Numbering decal kits can be purchased for asset inventory tracking.

LOCATION NAME TANK NUMBER PRODUCT	FEET	FT · IN
CRITICAL HIGH	###	## - ##
HIGH HIGH TANK	###	## - ##
HIGH TANK	###	## - ##
MAXIMUM WORKING	###	## - ##
MINIMUM WORKING	###	## - ##

MINIMUM WORKING IS BASED ON NORMAL LEG SETTINGS FOR TANKS WITH FLOATING ROOPS.  
SEE STRAPPING COVERSHEET OR STANDARD TML0001 FOR API TERMINOLOGY

APPROVED: 05-08-06

Tank decals can be used to identify tank location, name, product and capacity.

## HAZARDOUS MATERIAL WARNINGS

Based on NFPA Code 704M and Federal Standard 313, these pressure-sensitive panels, numerals, and symbols identify hazardous chemical containers, storage tanks, material storage areas, and other potential hazards. Place symbols and numerals in the colored blocks on the panel to show the degree of hazard present. These warning labels may be used indoors or outdoors; they are made of vinyl to resist weathering and chemicals.

### NFPA LABELING KITS

Diamond shaped clear panels are supplied with 4" tall black numbers. Each kit contains 3 each of the numbers 0, 1, 2, 3 and 4. Also included is 1 each of the symbols for Oxidizer, Use No Water and Radioactive. Legibility distance for this 4" number is two hundred feet.

Labeling Kit PN 0400058

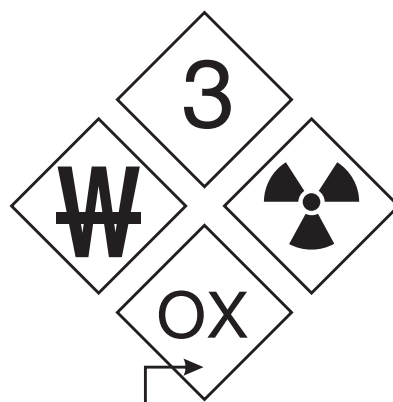

Clear panels with black numbers or symbols are placed in the colored blocks to show the degree of hazard present.

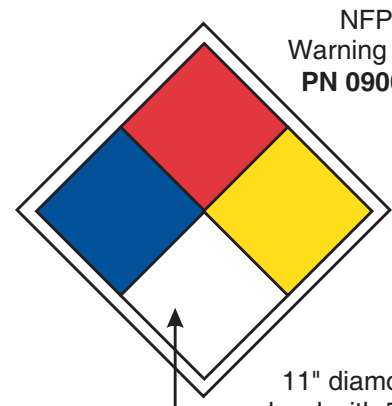

NFPA  
Warning Decal  
PN 0900541

11" diamond  
decal with 5 1/2"  
interior diamonds



Know what's below.  
Call before you dig.

# OVERLAY DECALS

**Rebranding, 811 implementation or phone number change?** Vulcan provides overlay decals in many colors, shapes and sizes to match virtually any existing sign. Save money by covering obsolete information with overlay decals instead of replacing the entire sign.

Premium Vinyls  
Regular Vinyls

Magnetic Rubber  
Reflective Film

Re-Positionable Adhesives  
Pigmented Adhesives



Decals can also be used to add information to signs. This can be helpful to keep signs up-to-date with current regulations.

**DESTRUCTION OF THIS SIGN IS A FEDERAL OFFENSE WITH A MAXIMUM FINE OF \$5000.00 AND IMPRISONMENT OF UP TO ONE YEAR FOR EACH OFFENSE.**



**CAUTION  
CATHODIC TEST  
STATION  
DO NOT DIG**

## LARGE SIGN OVERLAYS

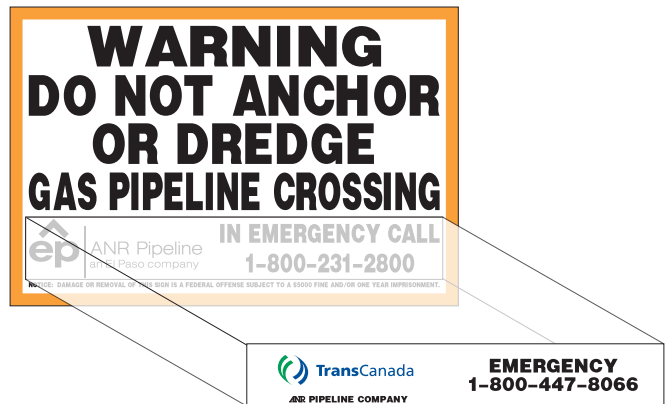

For large signs, we can provide thin-gauge aluminum overlays, which are much easier to install in the field than a large decal.



Know what's below.  
Call before you dig.



Our state-of-the-art graphics systems can reproduce logos from business card size to large signs without changing the integrity of the image. Many types of computer files may also be used to incorporate a logo on a sign. Call for details.



### Variable Message Signs for Identifying:

- Main line valves
- Odorization Points
- Facilities
- Town Borders
- Meter Stations
- Regulator Stations



South Carolina Pipeline uses this 24" square sign to identify specific delivery point locations. The name and number of each location is applied using computer cut, high-performance vinyls.



Know what's below.  
Call before you dig.

# FACILITY IDENTIFICATION

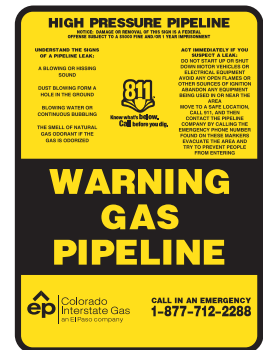
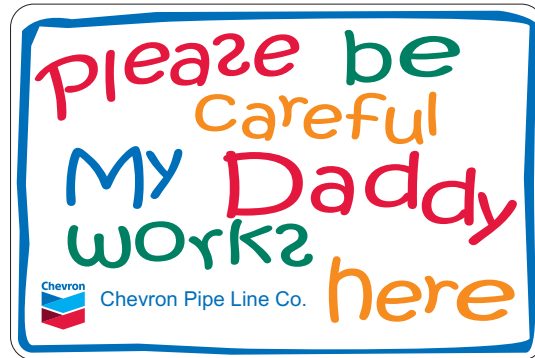

**SIGN KIT SOLUTIONS**

When purchasing your perimeter fencing, let Vulcan provide a TOTAL package solution, from Monument Signs to Stop Signs, fence ties to batten strips. Vulcan can provide a package that is ready for installation as soon as the box is opened, saving you valuable time and resources. Call today for additional information.





## MONUMENT SIGNS

Moving to a new location? Existing signs outlasted their useful life? Need to rebrand identification signs to reflect a new company logo? Vulcan manufacturers quality aluminum monument signs for new locations as well as aluminum overlay panels to reface existing signs. These signs are manufactured from .090 gauge aluminum for maximum outdoor durability. Call today to see how we can assist with your facility identification project.

### A COMPLETE KIT INCLUDES:

- Two 96" x 48" Face Panels
- Two 10" x 48" End Panels
- One 96" x 10" Top Panel
- One 96" x 10" Bottom Panel
- Four 1" x 1" x 125 x 96" Angle
- Four 1" x 1" x 125 x 48" Angle
- Four 96" Z-Bar with holes
- Thirty Five sets of nuts, washers and bolts
- Fifty Rivets



### A SINGLE PANEL MONUMENT KIT INCLUDES:

- Aluminum Overlay Panel Sign
- Mounting kit
- Hardware
- Instructions





Know what's below.  
Call before you dig.



Vulcan manufactures reflective or non-reflective security signs to meet corporate requirements. Call today for assistance with designing security signs.



**SIGN KIT SOLUTIONS**  
When purchasing your perimeter fencing, let Vulcan provide a TOTAL package solution, from Monument Signs to Stop Signs, fence ties to batten strips. Vulcan can provide a package that is ready for installation as soon as the box is opened, saving you valuable time and resources. Call today for additional information.

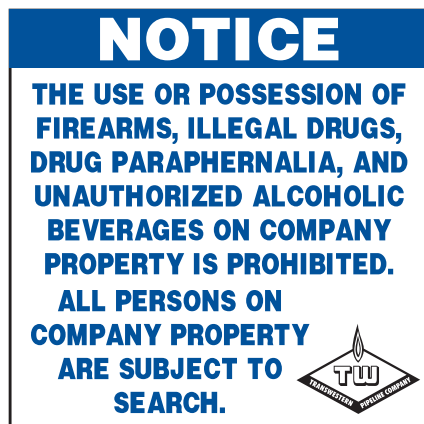



All signs are made from .040 aluminum with rounded corners for safety and holes punched for easy installation. Signs have screen printed or computer cut vinyl graphics on a durable, scuff resistant vinyl background. Small quantities are available for **quick shipment**. Reflective signs and decals are also available.



OS-1



OS-2



OS-3



OS-4



OS-6



OS-7

10" x 7", 14" x 10" and 20" x 14"

HOW TO ORDER:	EXAMPLE:
1) Choose Size Of Sign	1) 14"x10"
2) Choose OSHA Header	2) OS-1
3) Choose Message From List Of Codes On Opposite Page	3) 056



14"x10", OS-1, 056

## HAZARDOUS MATERIAL WARNINGS

Based on NFPA Code 704M and Federal Standard 313, these pressure-sensitive panels, numerals, and symbols identify hazardous chemical containers, storage tanks, material storage areas, and other potential hazards. Place symbols and numerals in the colored blocks on the panel to show the degree of hazard present. These warning labels may be used indoors or outdoors; they are made of vinyl to resist weathering and chemicals.

### NFPA LABELING KITS

Diamond shaped clear panels are supplied with 4" tall black numbers. Each kit contains 3 each of the numbers 0, 1, 2, 3 and 4. Also included is 1 each of the symbols for Oxidizer, Use No Water and Radioactive. Legibility distance for this 4" number is two hundred feet.

**Labeling Kit PN 0400058**

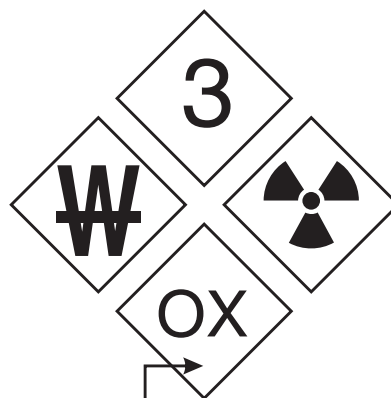

Clear panels with black numbers or symbols are placed in the colored blocks to show the degree of hazard present.

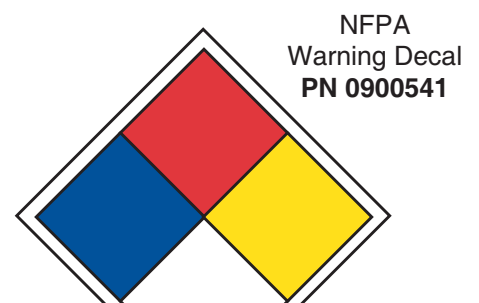

11" diamond decal with 5 1/2" interior diamonds



The list of messages shown below can be used with any of the standard OSHA headers.  
Signs are available in English or Spanish.

- 001 220 VOLTS KEEP AWAY
- 002 440 VOLTS KEEP AWAY
- 003 A FIRE TODAY NO JOB TOMORROW
- 004 ACETYLENE
- 005 ACID
- 006 ALCOHOLIC BEVERAGES & DRUGS  
PROHIBITED ON THIS PROPERTY
- 007 ALL INJURIES NO MATTER HOW SLIGHT  
MUST BE REPORTED TO FOREMAN
- 008 ASBESTOS AUTHORIZED PERSONNEL ONLY
- 009 ASBESTOS DUST HAZARD RESPIRATORS  
AND PROTECTIVE CLOTHING REQUIRED
- 010 AUTHORIZED PERSONNEL ONLY
- 011 BE ALERT DON'T GET HURT
- 012 BE CAREFUL
- 013 BLASTING AREA RADIO TRANSMISSION  
PROHIBITED
- 014 BURIED CABLE
- 015 CARELESSNESS IS DANGEROUS
- 016 CAUSTIC
- 017 CHEMICAL WASTE STORAGE AREA
- 018 CHLORINE
- 019 CLOSE CLEARANCE
- 020 CLOSED CIRCUIT TV SURVEILLANCE
- 021 COMPRESSED AIR
- 022 CONTAMINATED AREA
- 023 CRANE OVERHEAD
- 024 CYANIDE
- 025 DEPOSIT WASTE HERE
- 026 DO NOT BLOCK DOOR
- 027 DO NOT DRINK THIS WATER
- 028 DO NOT ENTER WITHOUT WEARING SAFETY  
GLASSES
- 029 DO NOT OPERATE WITHIN 10 FT OF  
POWER LINES
- 030 DO NOT OPERATE WITHOUT GOGGLES
- 031 DO NOT START ENGINE
- 032 DO NOT START THIS MACHINE
- 033 DO NOT WALK UNDER CONVEYOR
- 034 DO NOT WATCH THE ARC
- 035 DON'T TRY TO LIFT MORE THAN YOU ARE  
ABLE
- 036 DON'T WATCH ARC WELDER AT WORK THE  
LIGHT MIGHT BLIND YOU
- 037 DUST RESPIRATOR MUST BE WORN ON THIS  
JOB
- 038 EAR PROTECTION REQUIRED
- 039 EAR PROTECTION REQUIRED IN THIS AREA
- 040 EMERGENCY EXIT
- 041 EMERGENCY SHOWER EYE BATH
- 042 ENTRANCE
- 043 ENTRANCE FOR EMPLOYEES ONLY
- 044 EQUIPMENT STARTS AUTOMATICALLY
- 045 ETHYL MERCAPTAN FLAMMABLE
- 046 EVERYONE GRINDING MUST WEAR  
GOGGLES
- 047 EYE PROTECTION REQUIRED
- 048 EYE PROTECTION REQUIRED IN THIS AREA
- 049 EYEWASH FOUNTAIN
- 050 FIRE REGULATIONS REQUIRE THIS SPACE  
TO BE CLEAR AT ALL TIMES
- 051 FLAMMABLE
- 052 FLAMMABLE LIQUIDS
- 053 FLOOR SLIPPERY WHEN WET
- 054 GAS
- 055 GASOLINE
- 056 HARD HAT AREA
- 057 HARD HATS AND SAFETY GLASSES MUST BE  
WORN IN THIS AREA
- 058 HARD HATS REQUIRED IN THIS AREA
- 059 HAZARDOUS WASTE
- 060 HELP KEEP THIS PLANT SAFE AND CLEAN
- 061 HIGH NOISE LEVEL AREA WEAR YOUR  
PROTECTOR
- 062 HIGH PRESSURE GAS LINE
- 063 HIGH VOLTAGE
- 064 HIGH VOLTAGE KEEP AWAY
- 065 HIGH VOLTAGE KEEP OUT
- 066 HIGH VOLTAGE OVERHEAD
- 067 HYDROGEN NO SMOKING NO OPEN FLAMES
- 068 INFECTIOUS WASTE STORAGE AREA
- 069 KEEP AISLES CLEAR
- 070 KEEP AWAY
- 071 KEEP GATE CLOSED
- 072 KEEP HANDS CLEAR OF MOVING MACHINERY
- 073 KEEP OFF
- 074 KEEP OUT
- 075 KEEP THIS PASSAGEWAY CLEAR
- 076 KEEP THIS PLACE CLEAN AND ORDERLY
- 077 LASER
- 078 LOW HEAD ROOM
- 079 LP GAS NO SMOKING
- 080 MEDICAL WASTE
- 081 MEN WORKING ON LINE DON'T THROW  
SWITCH
- 082 MICROWAVE OVEN IN USE
- 083 NO ADMITTANCE WITHOUT A PERMIT
- 084 NO ALCOHOLIC BEVERAGES ALLOWED
- 085 NO FOOD OR DRINKS ALLOWED
- 086 NO LOAFING OR LOITERING IN THIS OFFICE
- 087 NO SMOKING
- 088 NO SMOKING NO OPEN FLAMES
- 089 NO SMOKING OXYGEN IN USE
- 090 NO SMOKING IN THIS AREA
- 091 NO SMOKING MATCHES OR OPEN FLAME
- 092 NO SMOKING MATCHES OR OPEN LIGHTS
- 093 NO SMOKING UNDER PENALTY OF DISMISSAL
- 094 NO SMOKING WITHIN 50 FEET
- 095 NO SOLICITING
- 096 NO TRESPASSING ON THIS PROPERTY  
UNDER PENALTY OF THE LAW
- 097 NO TRESPASSING
- 098 NO VEHICLES BEYOND THIS POINT
- 099 NON POTABLE WATER
- 100 NOT RESPONSIBLE FOR PERSONAL  
PROPERTY IN CASE OF FIRE OR THEFT
- 101 OUR AIM NO ACCIDENT
- 102 OXYGEN NO SMOKING NO OPEN FLAMES
- 103 PLACE CIGARETTES, CIGAR BUTTS & ASHES  
IN RECEPTACLES
- 104 PLEASE TURN OUT LIGHTS
- 105 POISON
- 106 POISON GAS
- 107 POSITIVELY NO ADMITTANCE
- 108 POSITIVELY NO SMOKING
- 109 POSTED NO HUNTING FISHING TRESPASSING
- 110 PROPANE
- 111 PROPANE FLAMMABLE
- 112 PUT THINGS BACK IN THEIR PROPER  
PLACES
- 113 Radiation Symbol Only
- 114 RADIOACTIVE MATERIALS
- 115 REPORT ALL ACCIDENTS
- 116 REPORT ALL ACCIDENTS NO MATTER HOW  
SMALL
- 117 REPORT ALL ACCIDENTS NO MATTER HOW  
SMALL TO YOUR FOREMAN
- 118 REPORT ALL UNSAFE CONDITIONS TO YOUR  
FOREMAN
- 119 RESTRICTED AREA
- 120 RESTRICTED AREA NO SMOKING ANY TIME
- 121 RESTROOM
- 122 ROTATING EQUIPMENT
- 123 SAFETY GLASSES, SAFETY SHOES AND  
HARD HATS REQUIRED BEYOND THIS POINT
- 124 SAFETY GLASSES REQUIRED IN THIS AREA
- 125 SOLICITING AND POSTING OF HANDBILLS  
PROHIBITED
- 126 STEP DOWN
- 127 STEP UP
- 128 STORAGE AREA FLAMMABLE MATERIAL
- 129 SULFURIC ACID
- 130 THE SAFE WAY IS THE BEST WAY
- 131 THE USE OF LIQUOR ON THE PREMISES WILL  
MEAN IMMEDIATE DISMISSAL
- 132 THERE IS NO SUBSTITUTE FOR SAFETY
- 133 THESE DOORS MUST BE KEPT CLOSED
- 134 THIS ELEVATOR IS FOR FREIGHT ONLY NOT  
FOR PASSENGERS
- 135 THIS EQUIPMENT OPERATES FROM  
REMOTE CONTROL
- 136 THIS EQUIPMENT STARTS AND STOPS  
AUTOMATICALLY
- 137 THIS MACHINE MUST NOT BE OPERATED  
WITHOUT SAFETY GUARD IN POSITION
- 138 THIS MACHINE STARTS AUTOMATICALLY
- 139 THIS PROPERTY PROTECTED BY SECURITY  
PATROL
- 140 THIS UNIT STARTS AUTOMATICALLY
- 141 UNAUTHORIZED PERSONNEL KEEP OUT
- 142 UNDERGROUND CABLE
- 143 USE HAND RAIL
- 144 WALK DON'T RUN
- 145 WATCH YOUR STEP
- 146 WEAR GLOVES WHEN HANDLING ACIDS OR  
CAUSTICS
- 147 WEAR GOGGLES AND RUBBER GLOVES  
WHEN HANDLING CHEMICALS
- 148 WEAR GOGGLES WHEN GRINDING
- 149 WEAR YOUR GOGGLES
- 150 WEAR YOUR GOGGLES WHILE USING THIS  
MACHINE
- 151 WET FLOOR
- 152 WET PAINT
- 153 WHEELS MUST BE CHOCKED BEFORE  
LOADING OR UNLOADING

# TRAFFIC CONTROL SIGNS



Know what's below.  
Call before you dig.

All traffic control signs conform with the Federal Manual on Uniform Traffic Control Devices. Signs are manufactured from .080" aluminum with engineer grade reflective sheeting. High intensity reflective sheeting is available upon request.



**R1-1**  
24" - 0850528  
30" - 0850707



**R1-2**  
30" - 0850728



**R5-1**  
30" - 0850715

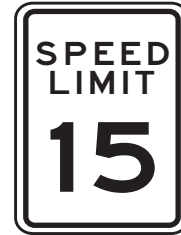

**R2-1-15**  
18" x 24" - 0850238

**Please Specify Desired Speed**

Speed	Code
5	R2-1-5
10	R2-1-10
15	R2-1-15
20	R2-1-20
25	R2-1-25
30	R2-1-30
35	R2-1-35
40	R2-1-40



**R7-8**  
12" x 18"  
0850091



**R7-6-1**  
12" x 18"  
0850078



**R7-6-9**  
12" x 18"  
0850087



**R8-17**  
12" x 18"  
0801661



**R8-18**  
12" x 18"  
0850107



**R7-1**  
12" x 18"  
0850063



**R16-1**  
12" x 18"  
0804347



**R8-78**  
12" x 18"  
0802002



**R16-1a**  
18" x 24"  
0850234



**W8-21**  
24" x 24"  
0850500



**R3-1**  
24" x 24"  
0850531



**R3-2**  
24" x 24"  
0850532



**R5-2**  
24" x 24"  
0850535

## INDUSTRIAL SIGNS

These signs are made with non-reflective vinyl film on .040 aluminum.



**ID-5**  
14" x 10"  
0803864



**ID-6**  
14" x 10"  
0803292



**ID-9**  
18" x 12"  
0850190



**NS-1**  
7" x 10"  
0850028



**NS-4**  
7" x 10"  
0804365



**EX-1**  
14" x 10"  
0801597



**EX-4**  
14" x 10"  
0804240



**EX-6**  
14" x 10"  
0804348



Know what's below.  
Call before you dig.

## GALVANIZED ANGLE POSTS

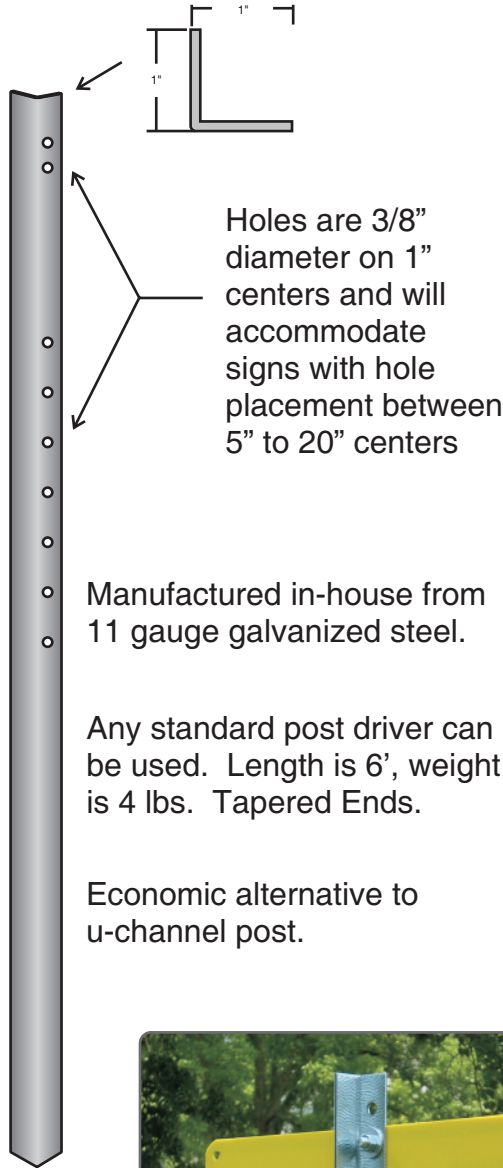

## U-CHANNEL POSTS

- Hot rolled posts from high carbon steel for superior strength.
- Mounting Holes - 3/8" diameter on 1" centers, entire length.
- Finish - Green Painted, Galvanized or Powder coated: yellow, orange or white.
- Lengths & Weights - Various lengths and weights are available. Call if the size and color needed is not listed.

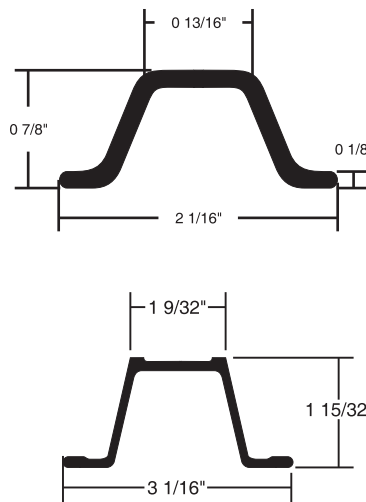

Part #	Lngh - Wght/ft	Finish
0550117	6' - 1.12#	Galv
0550118	6' - 1.12#	Green
0500001	6' - 1.12#	Yellow
0550134	7' - 1.12#	Green
0550135	7' - 2#	Galv
0550136	7' - 2#	Green
0550143	8' - 2#	Galv
0550145	8' - 2#	Green
0550049	10' - 2#	Galv
0550051	10' - 2#	Green

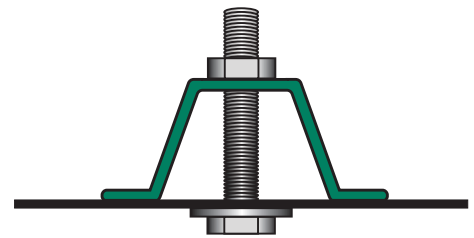

Proper Mounting Technique

## POST DRIVERS

### Lightweight Post Driver

For driving 1.12 lbs/foot post.  
Weight - 21 lbs.  
PN 0550021

### Handy Handle Heavy Duty One Man Driver

For driving 2 lbs/foot post.  
Weight - 38 lbs.  
PN 0550005

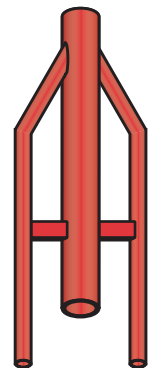

## NUTS AND BOLTS

### TIPS FOR FASTENER SELECTION

- Aluminum fasteners prevent rust streaks.
- The diameter of the bolt should be 1/16" smaller than the holes in the sign.
- See drawing below for length of fastener.

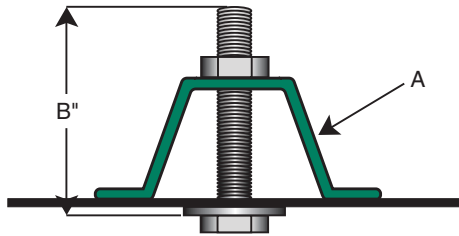

UC POST WEIGHT (A)	BOLT LENGTH (B)
1.12 pounds per foot	1 1/2"
2 pounds per foot	2"

STEEL ZINC PLATED	
DESCRIPTION	PART #
1/4" x 1 1/2" Hex Bolt	0650019
1/4" x 2" Hex Bolt	0600002
1/4" Hex Nut	0650017
1/4" Lock Washer	0600001
1/4" Flat Washer	0650021
5/16" x 1 1/2" Hex Bolt	0650039
5/16" x 2 Hex Bolt	0650043
5/16" Hex Nut	0650033
5/16" Lock Washer	0650037
5/16" Flat Washer	0650032

## ADDITIONAL FASTENERS

- Aluminum hardware.
- Vandal resistant carriage bolts and tamper nuts.
- Lag bolts for mounting to wood posts.
- One piece blind rivets.
- Stainless steel hardware.
- Sign savers (prevents sign distortion).
- Batten strips for mounting to chain link fences.
- Aluminum wire ties for mounting to fences or irregular items.

## ALUMINUM RIVETS

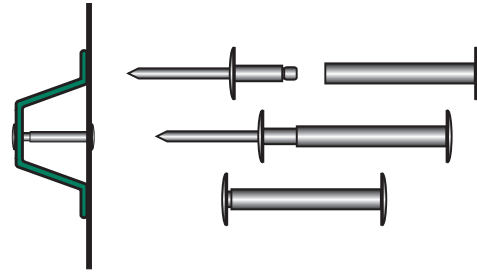

Intended primarily as a replacement for nuts and bolts, these two piece rivets offer the following very distinct advantages:

- Vibration Proof - will not shake loose
- Tamper Proof - smooth, low profile heads on both ends
- Controlled Clamp-Up - clamps tightly, without crushing
- Non Critical Holes - no close tolerance drilling necessary
- Labor Saving - installed by one man with a simple squeeze of a hand riveter

GRIP RANGE	SIZE POST USED WITH	PART #
7/8" - 1 1/8"	1.12 lb.	0650050
1 3/8" - 1 5/8"	2.0 lb.	0650051
1 5/8" - 1 7/8"	2.5 lb.	0650052
1 7/8" - 2 1/8"	3.0 lb.	0650053
G-28 Industrial Grade Rivet Gun		0650004

## POST CLAMPS

### FOR MOUNTING SIGNS ON ROUND POSTS

Vulcan's unique interlocking extruded aluminum clamps offer a rigid means of attaching a flat sign to a tubular post. The heavy strap section is an integral part of the broad sign mounting face. Size is based on outside diameter of posts. One clamp includes a male and a female section with fasteners. Two clamps required per sign.

Post Clamp for  
2 3/8" OD Post  
**PN 0750134**

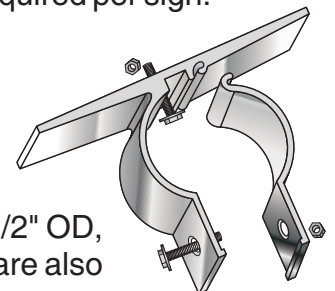

Post clamps for 3" OD, 3 1/2" OD, 4" OD and 4 1/2" OD post are also available. Call for pricing.



Know what's below.  
Call before you dig.

# BRACKETS & HARDWARE

## TWIST BRACKET

12" long twist bracket mounts inside a u-channel post to achieve proper directional orientation.

PN 0700190

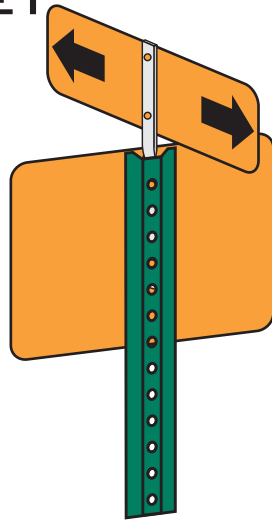

## SIGN SAVER

Sign savers keep HDPE signs flat when fasteners are tightened down.

PN 0650006

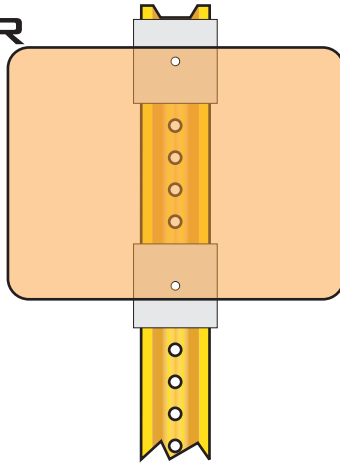

## CHANNEL BRACKET

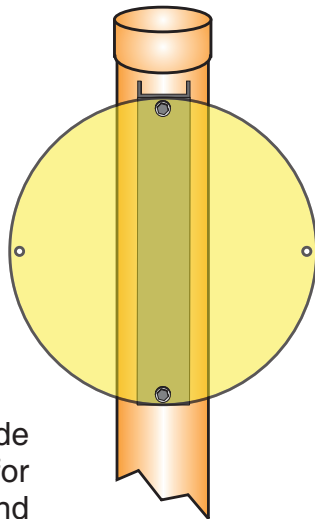
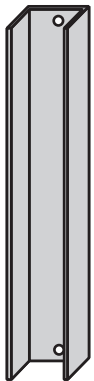

Channel Brackets provide a sturdy, flat surface for mounting a sign to a round post.

PN 0700175

## VL BRACKET

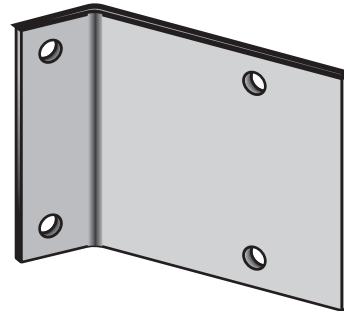

PN 0700142

This 4" x 5 1/2" L shaped bracket functions like a twist bracket except it attaches anywhere on the post.

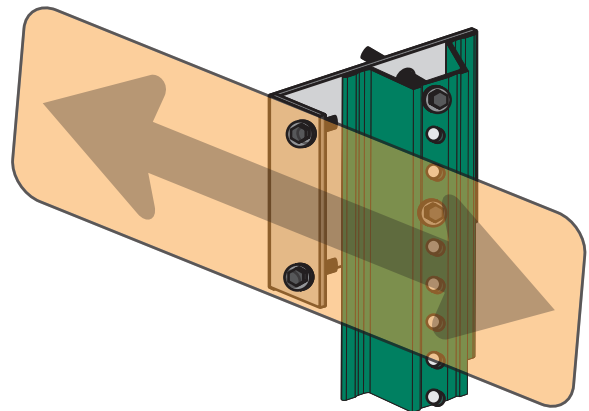

## BATTEN STRIP

Based on the sign size, we can provide batten brackets and special hardware to allow sign mounting without damaging the fence.

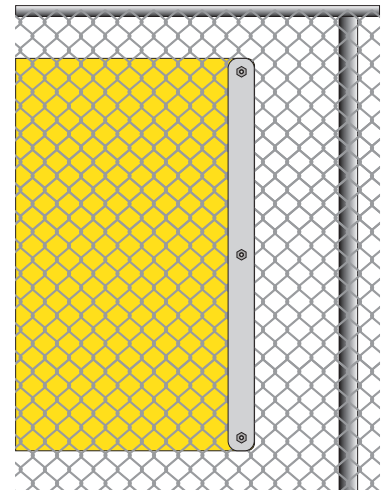



## SIGNS

All traffic control signs conform with the Federal Manual on Uniform Traffic Control Devices. Signs are manufactured from .080" aluminum with engineer grade reflective sheeting. High intensity reflective sheeting is available upon request. Diamond shaped signs in this section are available in 30", 36" and 48".



W20-1r-500



W21-4a



W20-3r-500



W20-3s-500



W20-4r-500



W20-5L-500



W20-5r-500



W20-7a



W20-7-500



W21-1



W21-1b



W20-2-500



W14-12



W21-10

All signs shown above can be ordered with any of the following messages:  
500 FT    AHEAD    1000 FT    ½ MILE    1500 FT

**EXAMPLE:** If you want a sign that reads "DETOUR 1000 FT" you would need to order a **W20-2-1000**



M4-10L  
48" x 18"



M4-10R  
48" x 18"

## STOP - SLOW PADDLES



G20-1r-\*  
60" x 36"  
(\*Specify Miles)



M4-9L  
30" x 24"



G20-2  
60" x 24"



M4-9R  
30" x 24"



PN 0801260  
.063 x 18" Oct.  
With 6" Handle



PN 0801259  
.063 x 18" Oct.  
With 72" Handle

Reflective Sheeting Double Faced  
**STOP** on one side **SLOW** on other



Know what's below.  
Call before you dig.

# WORK ZONE PRODUCTS

## V11 TRIPOD STAND



This heavy duty, galvanized steel tripod stand with fold up legs accommodates 30", 36" and 48" mesh or metal signs. All legs on this compact and economical stand fold up for ease of handling. This stand has holders for three flags (not included). Weight is 15 pounds. **PN 1150040**

## ZEPHYR SIGN STANDS



The Zephyr Sign Stand is constructed of a steel plate molded into a 38 pound recycled rubber base. The plastic corner pocket at the bottom of the sign locks in place on the base. These stands may be stacked for easy transportation and have two molded-in carrying handles. NCHRP-350 compliant. **PN 1100004**

### MORE SIGN STANDS

Also available are "A" frame stands, spring loaded stands and stands with 10' high mast. Call for details on these and other sign stands.

## MESH ROLL-UP SIGNS

- For daytime and temporary use.
- Made from single mesh, heavy duty, bright orange nylon mesh material.
- Lightweight and compact for ease of handling.
- Require little space for storage when rolled up.

The most frequently ordered messages are shown below. Other messages also available.

MUTCD	Description	36" Dia PN	48" Dia PN
W21-4a	UTILITY WORK AHEAD	1100021	1100022
W21-1B	MEN WORKING	1100017	1100018
W21-4r	ROAD WORK AHEAD	1100019	1100020
W20-7a	Flagger Symbol	1100015	1100016

## RIBS FOR MESH SIGNS

Ribs sold in sets of two. Two ribs needed per sign.

SIZE	PART #
Ribs for 36"	1150074
Ribs for 48"	1150080

## REFLECTIVE ROLL-UP SIGNS

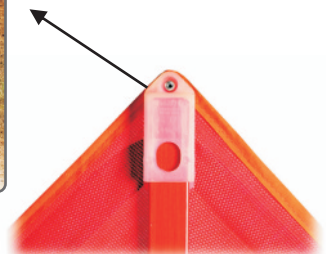

Our reflective roll-up signs include a heavy duty frame (ribs) and plastic corner pockets. Most standard MUTCD messages are available without any minimum or set up charge. Signs are available in 36" and 48" diamond.

## BARRICADES

Plastic barricades are manufactured with high density plastic and designed to have less damage than traditional barricades during vehicular impacts.

Traditional steel leg barricades with plywood panels also available.



From left to right: Type II, Type I In-Mold and Type I with sign sleeve.



Narrowcade®    Minicade®    Custom Sign Legend

### All Plastic Barricades:

- Can be internally ballasted with sand;
- Are shipped with free funnels; and
- Are manufactured with light adapters.

### Options Include:

- Name stenciled on bottom panel;
- High performance reflective sheeting;
- Sign Sleeve; and
- Choice of color - white, orange or yellow.



## TRAFFIC CONES



- Bright fluorescent orange
- Designed for nested storage
- 100% poly vinyl chloride (PVC) flexible
- Solid color is impregnated - not painted
- Base is weighted
- Name can be permanently molded or screened
- Slim line cones available

# INDEX

811 Products .....	11
Aerial Markers .....	12-15
Brackets .....	40-41
Cathodic Protection .....	22-23
Decals	
Fleet Marking .....	28-29
New Application .....	30
Overlay .....	31
DRV Markers .....	6-7
Excess Flow Valve Tag Kits .....	27
H41 Marking System .....	8-10
Hardware .....	40-41
Marking and Locating Tools .....	21
Sign Posts .....	5, 39
Signs	
Facility Identification .....	32-34
Line Marker .....	2-4
Safety .....	36-37
Security .....	35
Traffic Control .....	38
Waterway Markers .....	16-17
Work Zone .....	42
Special Application Markers .....	18-20
Vents and Accessories .....	24-26
Waterway Markers .....	16-17
Work Zone Products .....	42-44

## INDUSTRY ASSOCIATES



**Know what's below.  
Call before you dig.**



MADE IN THE USA



# VULCAN'S HOME

Vulcan is an employee-owned company located near the Alabama Gulf Coast in Foley. Our 30-acre campus includes five integrated manufacturing facilities, a Technology Center and Corporate Offices.



- A) **VULCAN UTILITY SIGNS:** Manufacturer of utility signs and various other products.
- B) **VULCAN ALUMINUM:** Fabricator of aluminum sheet, blanks and extrusions.
- C) **VULCAN ALUMINUM MILL:** Manufacturer of aluminum sheet and heavy gauge coils.
- D) **VULCAN SIGNS:** Screen printing facility for traffic control signs and related items.
- E) **VULCAN TECHNOLOGY CENTER:** Vulcan Traffic Management Services.
- F) **VULCAN:** General Offices.
- G) **VULCAN METAL STAMPINGS:** Steel stampings facility producing metal products.

*This is what we do at Vulcan...*

## WHAT CAN WE DO FOR YOU?

### VULCAN UTILITY SIGNS

P.O. BOX 1850  
FOLEY, ALABAMA  
36536-1850

901 VULCAN STREET  
FOLEY, ALABAMA  
36535

USA WATS  
1-800-426-1314

LOCAL  
251-943-9288

FAX  
251-943-9290

EMAIL  
VULCAN7@VULCANINC.COM

WEB  
WWW.VULCANINC.COM/VUS

REPRODUCTION BY ANY MEANS PROHIBITED. © 2010 Vulcan, Inc.